

ELITE ELEVATOR



Contact Name: _____ Job Name: _____

Email Address: _____ Location: _____

Notes: _____

BASE PACKAGE

Includes 2 landings, 1 opening, cab model 3636 or 3648, winding drum drivetrain, 8lb. guide rails, travel cable, PLC controller and optical landing system, terminal and final limits, 2 recessed LED automatic cab lights, stainless steel fixtures with blue LED buttons, phone, standard flat wall cab finish, 1 door lock per level.

HOISTWAY	Hoistway Size	Rail Location	Landings					
	<p>W X D</p>	<p>LEFT RIGHT</p>	<table> <tr><td>2</td><td>5</td></tr> <tr><td>3</td><td>6</td></tr> <tr><td>4</td><td>7</td></tr> </table>	2	5	3	6	4
2	5							
3	6							
4	7							
	<h3>Hoistway Construction</h3> <ul style="list-style-type: none"> Wood Concrete 							

Note: Refer to Master Cab Configuration file for recommended standard hoistway sizes.

CAB	Cab Model	Cab Configuration	Cab Height
	3636	Front Opening	6' 8"
3648	Pass Through	7' 0"	
3660	90 degree opening	8' 0"	
4254			
4836			

CAB FINISHES	Standard Flat Walls	Flat Wood Veneer	Traditional	Shaker Style	Lights
					<p>2 LED</p>
Finish White Beige Black Other	Unfinished Birch Oak Cherry Mahogany	Unfinished Birch Oak Cherry Mahogany	Finish White Unfinished Birch	<h3>Fixture Finish</h3> <ul style="list-style-type: none"> #4 Brushed Stainless Bronze Copper Vein 	
					<h3>Fixture Shape</h3> <ul style="list-style-type: none"> Traditional Oval

Select hoistway door configuration for each floor level.

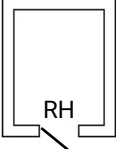
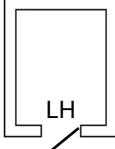
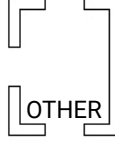
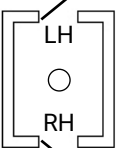
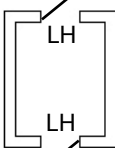
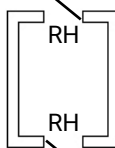
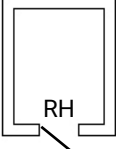
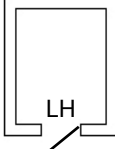
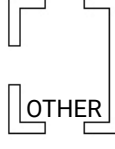
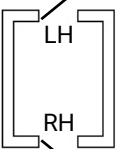
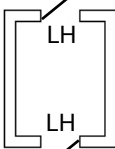
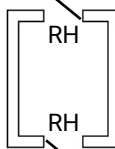
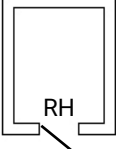
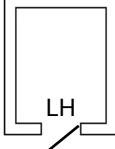
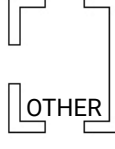
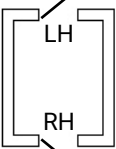
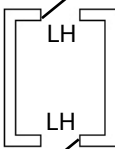
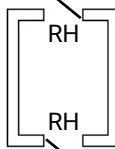
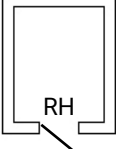
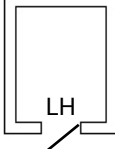
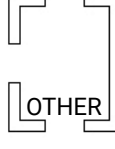
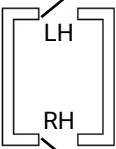
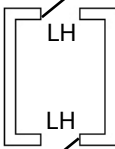
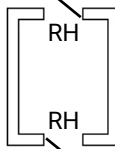
DOOR SWING	LEVEL 4			
				
	LEVEL 3			
				
	LEVEL 2			
				
	LEVEL 1			
				

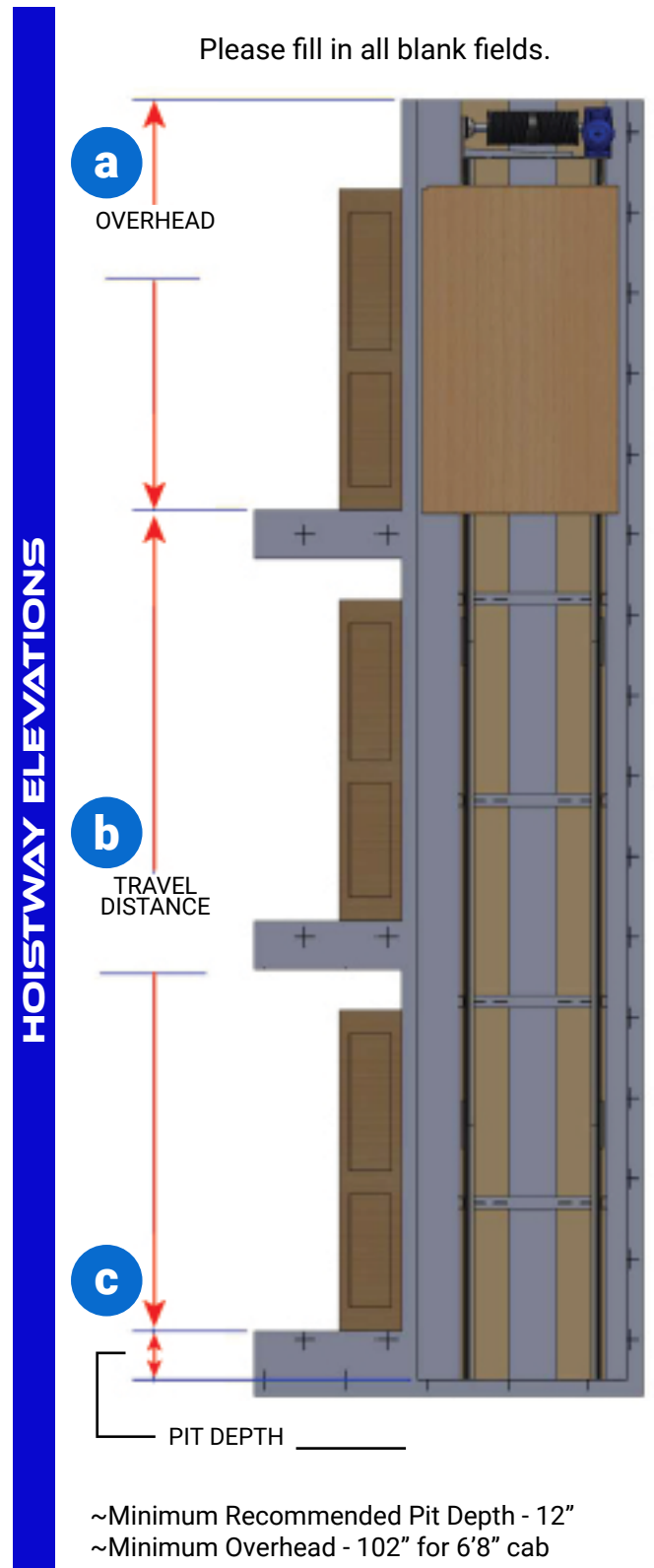

ELITE ELEVATOR



STANDARD FEATURES

- » PLC Based Controller, ETL Listed
- » Terminal and Final Limits
- » Optical Landing System
- » 2nd Level Homing
- » Blue LED Call Buttons
- » Automatic Cab Lights
- » Travel Cable
- » Cartop Box
- » Phone
- » 2 Drawing Revisions

MACHINE ROOM

Controller/Machine Room Location:

- Adjacent
- Remote _____ feet
- Standard Travel Cable (hoistway length + 20ft)
- Extra Travel Cable
- Controller for Stops 5-7

GATES

Standard Vinyl

- White
- Tan
- Gray

Wood Grain Vinyl

- Birch
- Maple
- Natural Oak
- Dark Oak

Unfinished

Natural Wood Veneer

- Birch
- Maple
- Oak
- Mahogany
- Cherry

Acrylic

- Clear

OPTIONS

- Battery Lowering w/ e-light
- Additional Door Locks QTY _____
- Automatic Gate Operator QTY _____
- Security Keypad
- Float Switch
- Door Baffles QTY _____
- Custom Platform Size
- Excess Travel Distance _____
- Round Handrail
- Additional Drawing Revisions QTY _____

DRIVE

- Winding Drum - 950 lb. capacity
- Roped Hydraulic

OPTIONAL DOOR JAMBS

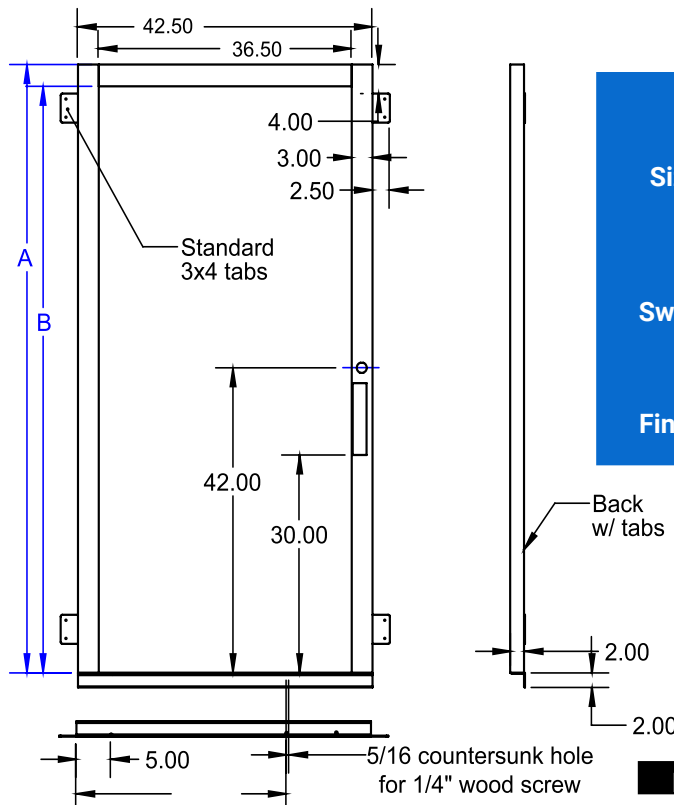

	Quantity
Size	80" _____
	84" _____
	96" _____
Swing	Right _____
	Left _____
Finish	White _____
	Beige _____

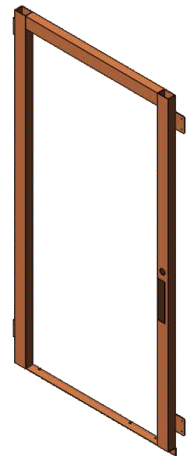

36" wide door panel provided by others. Integrated self closing hinge and honeywell realign door lock with LED call button. Strike plate kit included with frame.

Door Size	r/o Frame Size	A	B
36x80	44 x 84.5	83.75	80.75
36x84	44 x 88.5	87.75	84.75
36x96	44 x 100.5	99.75	96.75